

Putting wings on SPHINCS

PQCRYPTO Conference

Stefan Kölbl

April 10th, 2018

Technical University of Denmark,
Cybercrypt



PQCRYPTO
ICT-645622



 **cybercrypt**

The logo for Cybercrypt, featuring a stylized 'c' icon composed of three curved segments in blue and orange, followed by the word 'cybercrypt' in a lowercase, sans-serif font. 'cyber' is in blue and 'crypt' is in orange.

SPHINCS

- Hash-based signature scheme
- **Stateless**
- 128-bit post-quantum security
- Sizes:
 - Public Key: 1KB
 - Secret Key: 1KB
 - Signature: 41KB

<https://sphincs.cr.yp.to/>

How to instantiate SPHINCS?

Main components:

- One-time Signature (WOTS)
- Few-time Signature (HORST)
- Merkle-Tree

SPHINCS

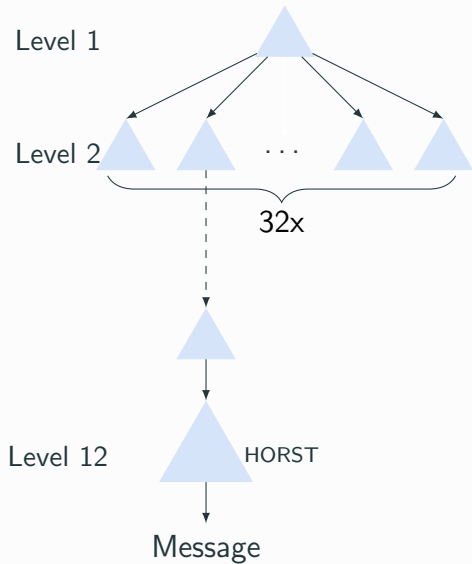

SPHINCS

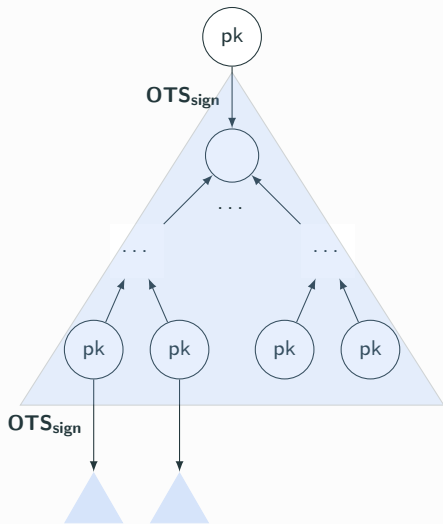

What is computed?

- Many calls to a hash function...
- ...but using short input only.

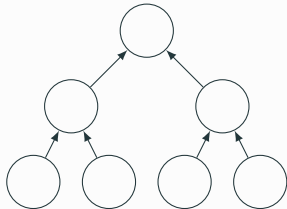

SPHINCS

For one signature

- ≈ 450.000 times **F**
- ≈ 90.000 times **H**

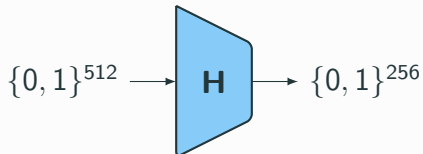

Cryptographic Hash Functions

Which hash function could we use?

- Standards
 - SHA256
 - SHA-3
- ChaCha12 permutation
- Keccak
- Haraka
- Simpira

Cryptographic Hash Functions

SHA-2 (FIPS PUB 180-4)

- 512-bit Message Blocks
- Padding...

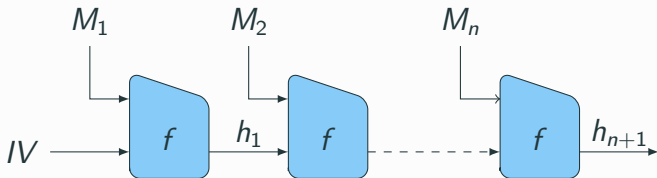

Cryptographic Hash Functions

SHA3-256 (FIPS PUB 202)

- 1600-bit Permutation
- 1088-bit Message Blocks

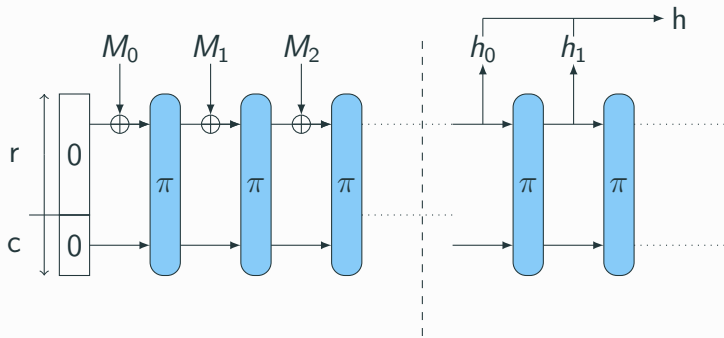

Cryptographic Hash Functions

Other Keccak variants:

- Use 800-bit permutation?
- Use less rounds (Kangaroo12¹).
- Best preimage attack on 4 rounds².



⁰ see <https://eprint.iacr.org/2016/770>

⁰ Linear Structures: Applications to Cryptanalysis of Round-Reduced Keccak, Asiacrypt 2016

ChaCha12

- Suggested in SPHINCS paper.
- Use ChaCha12 permutation in sponge.
- Great software performance with vectorization.

Cryptographic Hash Functions

Haraka: A short-input hash function³

- Permutation based on AES rounds.
- SPN construction.
- 256- and 512-bit permutation.

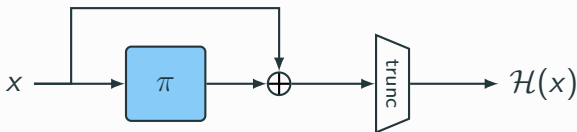

³<https://eprint.iacr.org/2016/098>

Cryptographic Hash Functions

Simpira⁴

- Permutation based on AES rounds.
- Feistel construction.
- 256- and 512-bit permutation.

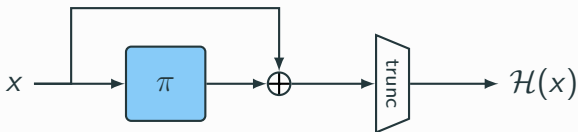

⁴<https://eprint.iacr.org/2016/122>

SPHINCS not well suited for small devices⁵

- Signature size larger than RAM for some devices.
- Computational costs for signing high...
- ... but verification is cheap.

Focus on highend platforms:

- Intel Haswell/Skylake, AMD Ryzen
- ARM Cortex A57/A72

⁵ see <https://eprint.iacr.org/2015/1042>

How to get a fast implementation?

- Vectorization (AVX2, NEON, AVX-512)
- Hardware Support (AES, SHA-2, SHA-3)
- Utilize pipeline



Microarchitectures

Vector Instructions

X_7	X_6	X_5	X_4	X_3	X_2	X_1	X_0
-------	-------	-------	-------	-------	-------	-------	-------

\oplus \oplus \oplus \oplus \oplus \oplus \oplus \oplus

Y_7	Y_6	Y_5	Y_4	Y_3	Y_2	Y_1	Y_0
-------	-------	-------	-------	-------	-------	-------	-------

= = = = = = = =

Z_7	Z_6	Z_5	Z_4	Z_3	Z_2	Z_1	Z_0
-------	-------	-------	-------	-------	-------	-------	-------

- Apply same operation on all elements of the vector.
- Use independent inputs.

Pipelining

- Latency
- Inverse Throughput

Cycles



Pipelining

- Latency
- Inverse Throughput

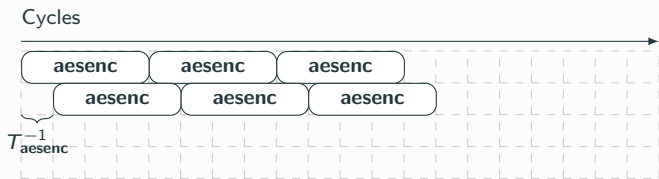

Pipelining

- Latency
- Inverse Throughput

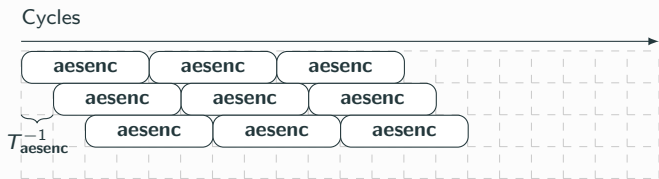

Platforms

Performance varies a lot depending on the platform

Platform	Instruction	Latency	inv. Throughput
Skylake	vectorized XOR	1	0.33
Ryzen	vectorized XOR	1	0.5
Cortex A57	vectorized XOR	3	2

How to implement those functions efficiently?

- SHA-2
- Keccak[$b = 800$]
- ChaCha12
- Haraka
- Simpira

How to implement those functions efficiently?

- SHA-2
 - 32-bit word oriented
 - Vectorize
 - Hardware Support
- Keccak[$b = 800$]
- ChaCha12
- Haraka
- Simpira

How to implement those functions efficiently?

- SHA-2
- Keccak[$b = 800$]
 - 32-bit word oriented
 - Vectorize
- ChaCha12
- Haraka
- Simpira

How to implement those functions efficiently?

- SHA-2
- Keccak[$b = 800$]
- ChaCha12
 - 32-bit word oriented
 - Vectorize
- Haraka
- Simpira

How to implement those functions efficiently?

- SHA-2
- Keccak[$b = 800$]
- ChaCha12
- Haraka
 - AES + permute
- Simpira

How to implement those functions efficiently?

- SHA-2
- Keccak[$b = 800$]
- ChaCha12
- Haraka
- Simpira
 - AES

Tour de SPHINCS

Intel Skylake

- AVX2 (256-bit vector)
- AES-NI



Intel Skylake

- AVX2 (256-bit vector)
- AES-NI

Signing (million cycles)

Design

Skylake

ChaCha12

Haraka

Keccak

SHA-256

Simpira

Intel Skylake

- AVX2 (256-bit vector)
- AES-NI

<u>Signing (million cycles)</u>	
Design	Skylake
ChaCha12	
Haraka	
Keccak	
SHA-256	142.06
Simpira	

Intel Skylake

- AVX2 (256-bit vector)
- AES-NI

<u>Signing (million cycles)</u>	
Design	Skylake
ChaCha12	
Haraka	
Keccak	108.62
SHA-256	142.06
Simpira	

Tour de SPHINCS

Intel Skylake

- AVX2 (256-bit vector)
- AES-NI

Signing (million cycles)	
Design	Skylake
ChaCha12	3 43.49
Haraka	
Keccak	108.62
SHA-256	142.06
Simpira	

Tour de SPHINCS

Intel Skylake

- AVX2 (256-bit vector)
- AES-NI

Signing (million cycles)		
Design		Skylake
ChaCha12	3	43.49
Haraka		
Keccak		108.62
SHA-256		142.06
Simpira	2	28.40

Intel Skylake

- AVX2 (256-bit vector)
- AES-NI

Signing (million cycles)		
Design		Skylake
ChaCha12	3	43.49
Haraka	1	20.78
Keccak		108.62
SHA-256		142.06
Simpira	2	28.40

AMD Ryzen

- AVX2 (256-bit vector)
- AES-NI (2 ports)
- SHA256 instructions



AMD Ryzen

- AVX2 (256-bit vector)
- AES-NI (2 ports)
- SHA256 instructions

Signing (million cycles)

Design

Ryzen

ChaCha12

Haraka

Keccak

SHA-256

Simpira

AMD Ryzen

- AVX2 (256-bit vector)
- AES-NI (2 ports)
- SHA256 instructions

Signing (million cycles)

Design	Ryzen
---------------	--------------

ChaCha12	
----------	--

Haraka	
--------	--

Keccak	189.98
--------	--------

SHA-256	
---------	--

Simpira	
---------	--

AMD Ryzen

- AVX2 (256-bit vector)
- AES-NI (2 ports)
- SHA256 instructions

<u>Signing (million cycles)</u>	
Design	Ryzen
ChaCha12	63.42
Haraka	
Keccak	189.98
SHA-256	
Simpira	

Tour de SPHINCS

AMD Ryzen

- AVX2 (256-bit vector)
- AES-NI (2 ports)
- SHA256 instructions

<u>Signing (million cycles)</u>	
Design	Ryzen
ChaCha12	63.42
Haraka	
Keccak	189.98
SHA-256	3 53.33
Simpira	

Tour de SPHINCS

AMD Ryzen

- AVX2 (256-bit vector)
- AES-NI (2 ports)
- SHA256 instructions

<u>Signing (million cycles)</u>		
Design		Ryzen
ChaCha12		63.42
Haraka		
Keccak		189.98
SHA-256	3	53.33
Simpira	2	20.43

AMD Ryzen

- AVX2 (256-bit vector)
- AES-NI (2 ports)
- SHA256 instructions

Signing (million cycles)		
Design		Ryzen
ChaCha12		63.42
Haraka	1	15.54
Keccak		189.98
SHA-256	3	53.33
Simpira	2	20.43

ARM Cortex A57

- NEON (128-bit vector)
- AES
- SHA256 support

The ARM logo is displayed in white, bold, sans-serif capital letters on a teal square background. A registered trademark symbol (®) is located at the top right of the letter 'M'.

ARM[®]

ARM Cortex A57

- NEON (128-bit vector)
- AES
- SHA256 support

Signing (million cycles)

Design

Cortex A57

ChaCha12

Haraka

Keccak

SHA-256

Simpira

ARM Cortex A57

- NEON (128-bit vector)
- AES
- SHA256 support

Signing (million cycles)	
Design	Cortex A57
ChaCha12	
Haraka	
Keccak	376.90
SHA-256	
Simpira	

ARM Cortex A57

- NEON (128-bit vector)
- AES
- SHA256 support

Signing (million cycles)	
Design	Cortex A57
ChaCha12	193.51
Haraka	
Keccak	376.90
SHA-256	
Simpira	

Tour de SPHINCS

ARM Cortex A57

- NEON (128-bit vector)
- AES
- SHA256 support

Signing (million cycles)	
Design	Cortex A57
ChaCha12	193.51
Haraka	
Keccak	376.90
SHA-256	3 92.08
Simpira	

Tour de SPHINCS

ARM Cortex A57

- NEON (128-bit vector)
- AES
- SHA256 support

Signing (million cycles)	
Design	Cortex A57
ChaCha12	193.51
Haraka	
Keccak	376.90
SHA-256	③ 92.08
Simpira	② 63.48

Tour de SPHINCS

ARM Cortex A57

- NEON (128-bit vector)
- AES
- SHA256 support

Signing (million cycles)	
Design	Cortex A57
ChaCha12	193.51
Haraka	1 47.10
Keccak	376.90
SHA-256	3 92.08
Simpira	2 63.48

Formula SPHINCS

Hash Performance for **F**

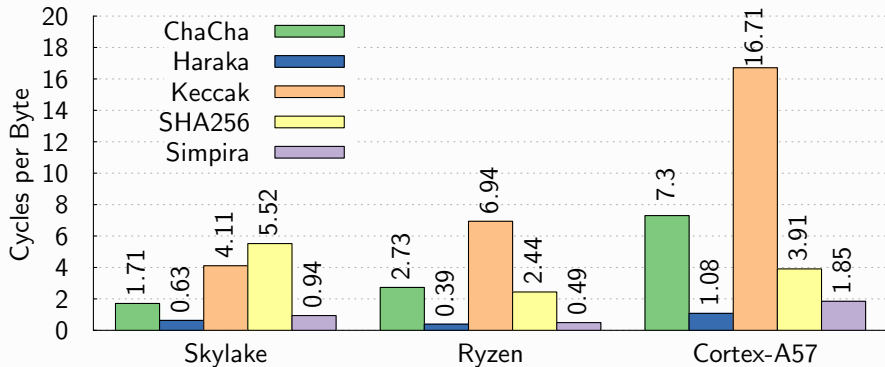

Formula SPHINCS

Hash Performance for H

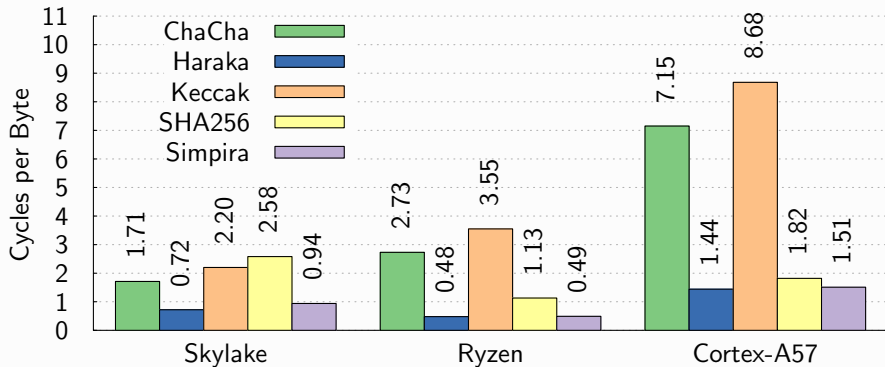

Two variants of SPHINCS in NIST PQ competition:

- Gravity-SPHINCS
 - Results directly apply.
 - Already uses Haraka.
- SPHINCS+
 - Tweakable Hash.
 - Needs to process slightly larger inputs.

Summary

- Gap between fastest and slowest up to 10x.
- Verification can be really fast, e.g. 258.660 cycles on Ryzen.

Future Platforms:

- Larger Vectors (AVX512)
- Vectorized AES (Intel Icelake)
- SHA-3 instructions (ARMv8.4-a)

Questions?

`https://github.com/kste/sphincs`